

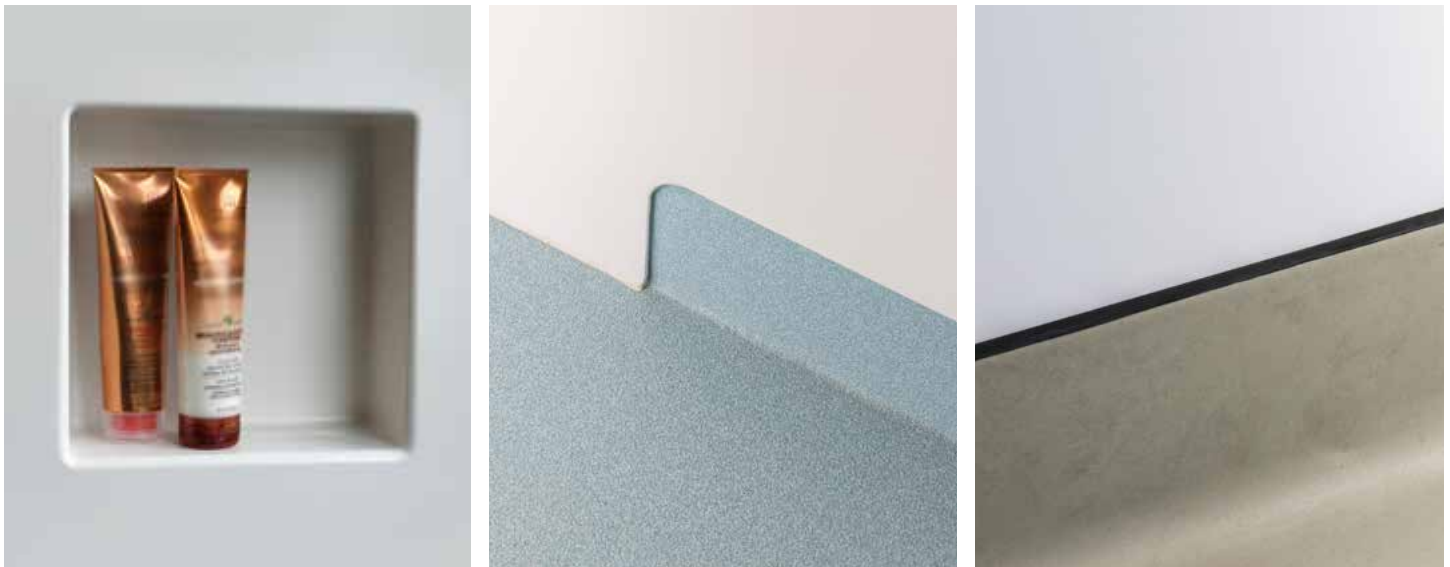

altro

Ligature-resistant detailing for behavioral and mental healthcare facilities (BMH)



An extremely important facet of BMH are the secure transitions between materials in high risk areas. The risk of violence and self-harm that comes with standard transitions prevents the use of many trim pieces. For example, regulations forbid the use of standard flooring cap strip in mental health installations, for fear of tampering and weaponization.

In lieu of a cap strip, Altro flooring can transition into the Altro Whiterock wall system via a variety of methods that do not require the use of traditional flooring cap strips. Altro has developed various joining methods between different surfaces which allow for hygienic construction without the need for potentially hazardous transition pieces.

Ligature-resistant detailing

Heat-welding system

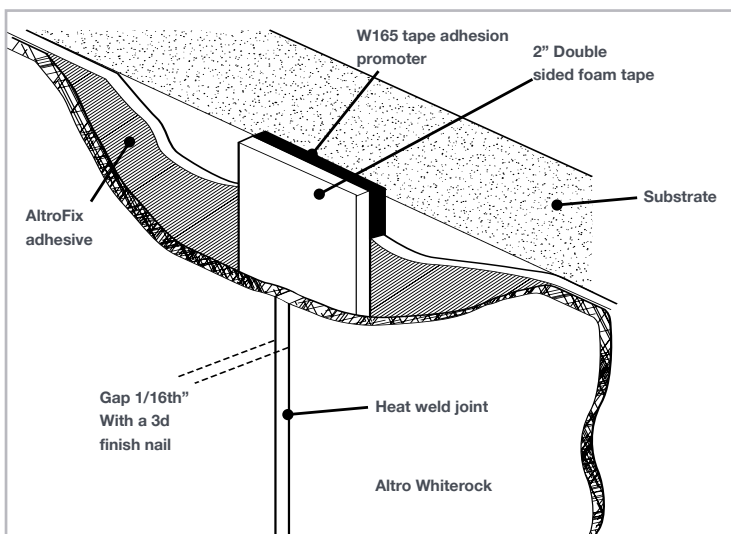

One-part joint strip transition

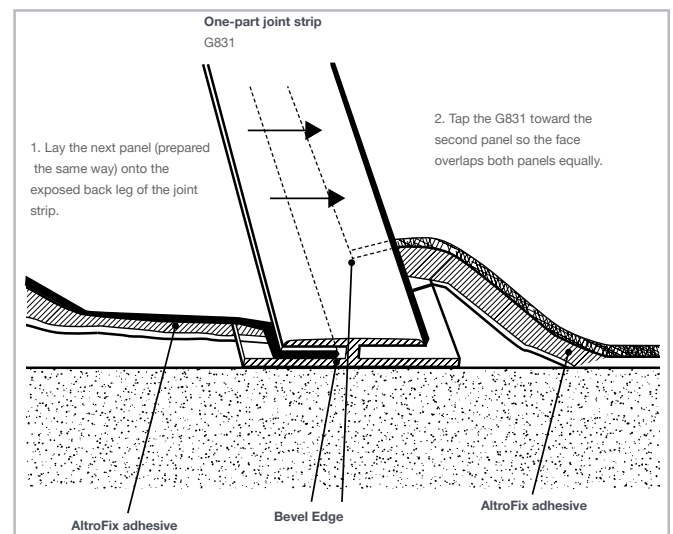

Floor to wall rebate transition



The rebate method is an extremely secure way to transition the floors and walls in high risk areas. It is ideal for use in seclusion rooms.

In this transition a rebate is saw cut into the wall. The flooring and Altro Whiterock are then tucked into it and glued in place. The void between the two products is filled with a tamper-resistant security sealant to prevent tampering.

Benefits:

- Completely sealed system
- Tamper-resistant
- Two-part polyurethane adhesive securely bonds floors and walls to the substrate
- Damaged flooring can be replaced without affecting the wall cladding

Additional considerations:

- Rebate must be level and 3/8" high by 5/8" deep.
- Some thicker flooring materials may need the backing to be grooved at the rebate.
- It's recommended to heat weld all inside and outside corners prior to tucking the floor into the rebate.
- When installing the Altro Whiterock it is recommended to thermoform and install the inside and outside corners first and then fit the adjoining sheets.
- Be consistent with the radius of the rebate bend in the Altro Whiterock in order to maintain uniformity of the radius from sheet to sheet.
- Using contact tape will require greater care and additional heat to install the flooring flat and tightly into the rebate. Some materials will require grooving the back at the rebate.
- Very absorbent / porous substrates must have one coat of primer (Valspar, Glidden, or equal).
- Use scrap pieces of Altro Whiterock as a wedge to hold flooring tightly into the rebate.
- You can install all your rebates first and then weld, however, we recommend heat welding first.

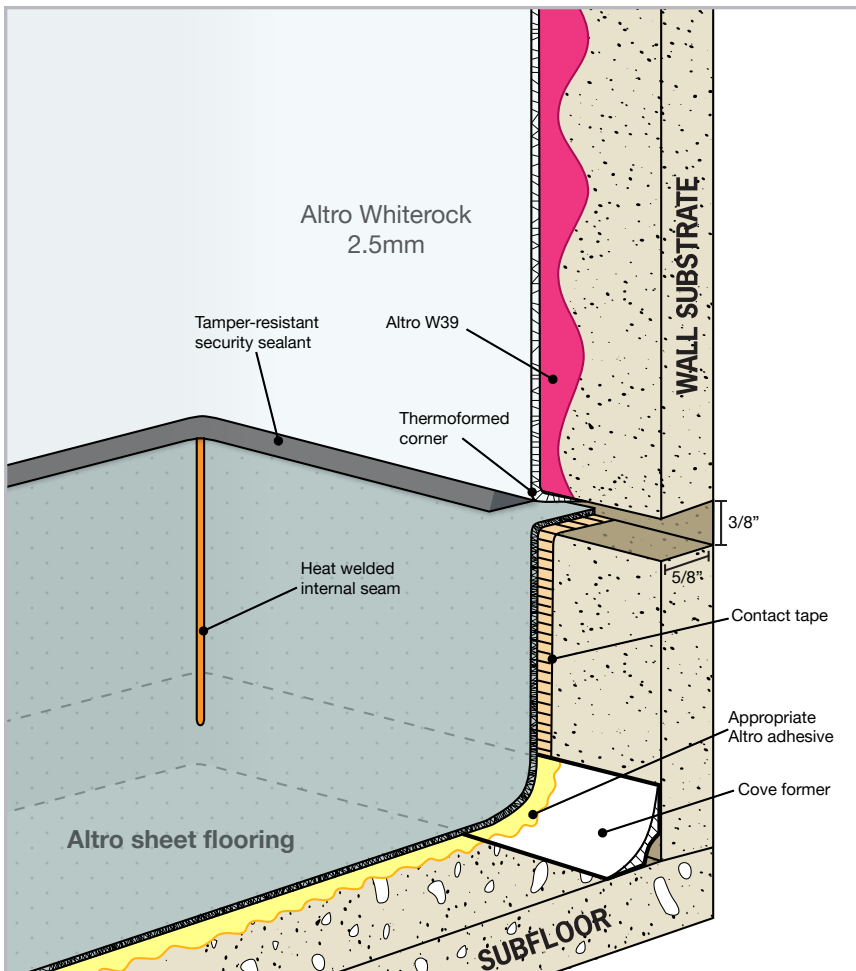

Note: For more information about using approved tamper-resistant security sealant refer to Altro's installation supplement for security sealant.

Flooring installation



1. Begin by cutting your rebate. It should be level and 3/8" high by 5/8" deep.



2. Apply contact tape on the wall as well as inside the rebate.



3. When installing outside corners, leave the rebate un tucked to allow for heat welding.



4. Once the material is heat welded, trim and tuck it into the rebate.

To start, you will have to prepare the room as you would for a typical flash cove installation. For instructions on this, please refer to the [Altro flooring installation guide](#).

For the next step you will have to prepare the walls as you would for a typical Altro Whiterock installation. Refer to our [Altro Whiterock installation guide](#) for details. Please note that this guide is only available to those who have completed the training course offered at one of our three training academies.

Wall cladding installation

We recommend that you install corner pieces first. Make sure that walls are clean and dust free. Apply a level datum line as per the Altro Whiterock installation guide. When installing inner and outer corners, measure from the datum line down to the top of the rebate and add thickness of material for the bend.

Make your rebate bend first on the thermoformer and then cut off material to fit into the rebate minus 1/16" gap. We recommend a sharp bend for your rebate. Be sure to measure from the datum line to the ceiling and cut to fit leaving a 1/16" gap. Measure and thermoform for internal and external corners.



5. For internal corners, cut the rebate before bending. External corners require you to cut and mitre the rebate before bending.



6. Make your inside and outside bends then install the corner panels.

You will have to heat the face of the Altro Whiterock for certain bends being careful not touch the panel to the white insulating stones. Remove the protective film from the surface of the Altro Whiterock first.

Be consistent with the radius of the bends so the bottom of the Altro Whiterock will look uniform.



7. Use 2d or 3d nails, to space between panels, for heat welding and expansion.



8. When heat welding the walls, place several layers of tape to prevent burning the floor. Once welded, trim any excess.

When hanging straight walls, scribe and cut seams allowing for the appropriate gap for expansion and contraction (approx. 1/16") before you make your rebate bend (nothing larger than a 3d nail).



9. Tape off the rebate and apply tamper-resistant security sealant.



10. Once applied, remove the tape and allow it to dry.

Floor to wall overlap transition

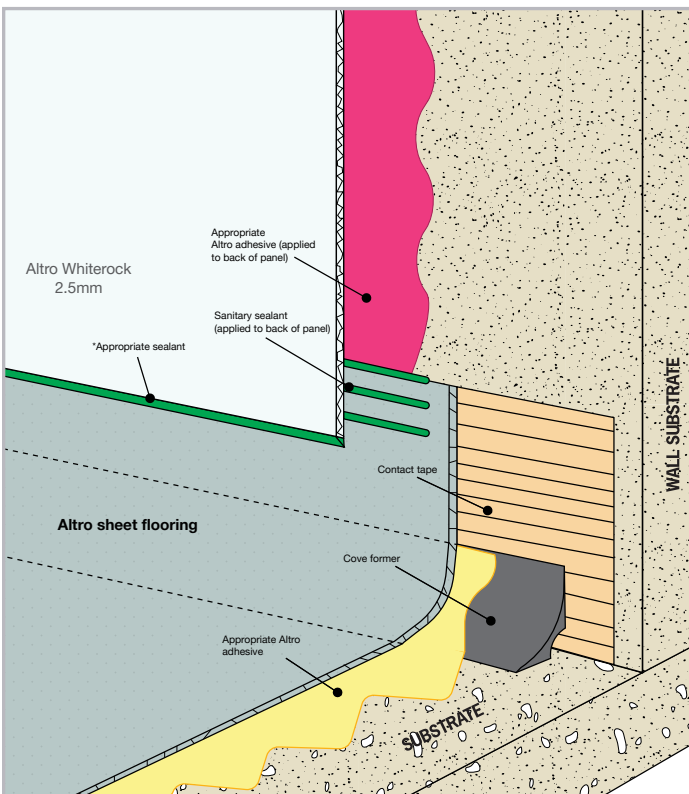

An overlap transition from floor to wall is our preferred installation method and is utilized in most installations. It is completed by installing the flooring 6" – 8" up the wall, dependent on cove size and installing the Altro Whiterock with a 2" overlap. The juncture is then finished with Altro sanitary sealant or tamper-resistant security sealant.

This installation technique is easier to install versus a heat-welded transition and offers enhanced security over water ingress.

***In behavioral and mental health facilities, tamper-resistant security sealant (previously referred to as pick-proof caulking) must be used per the Installation supplement for tamper-resistant security sealant. In other installations we recommend Altro sanitary sealant.**

Pencil cove method

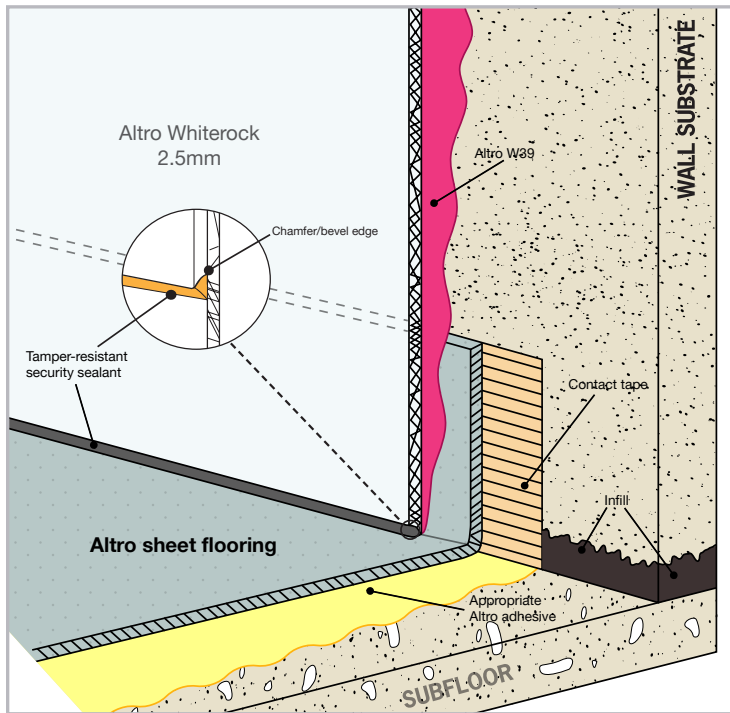

The pencil cove installation method is an extremely secure way of detailing showers and wet areas. In this installation depicted above, the flooring has been self-covered without using a cove former/ covestick and is protected by the overlapping wall cladding. The wall is flush against the flooring to ensure there is no opportunity to pick at the finishes. The bottom edge of the wall panel is chamfered and caulked with tamper-resistant security sealant. This installation method ensures the room is both watertight and tamper resistant.

Spacing between drywall and floor

Most contractors will hold drywall up off the floor, mostly to keep water from wicking up into the drywall. This gap can be anywhere from 3/8" to 3/4" and can cause problems when installing flash covered vinyl (20R cove former) and must be filled in when installing the pencil cove detail. Listed below are some recommendations to fill this void that can be carried out by the General Contractor, Sub-Contractor, or the Flooring Contractor.

With the pencil cove detail, it is important for the area between the wall and the floor to be filled in smooth and level without voids or protrusions.

Pencil cove installation



- 1A. Install contact tape for coving and spread adhesive on floor, note that there is no cove former used.
- 1B. Install the flooring and heat the material well, creating a crease where the floor meets the wall.



2. Heat weld the inside and outside corners in flooring before installing Altro White Rock panels.

When installing Altro White Rock on an unlevel floor, you will have to scribe the panels to the floor.



3. Using a two-part polyurethane adhesive, glue the wall panel all the way down to the bottom edge of the wall panel where it meets the floor.



4. Finish by applying tamper-resistant security sealant where panel meets the floor.

Cutout of wall to show pencil cove floor installed up and behind Altro White Rock wall cladding for instructional purpose only.

Altro Whiterock™ Recessed Shelf

Tamper-resistant shelf for Altro Whiterock showers

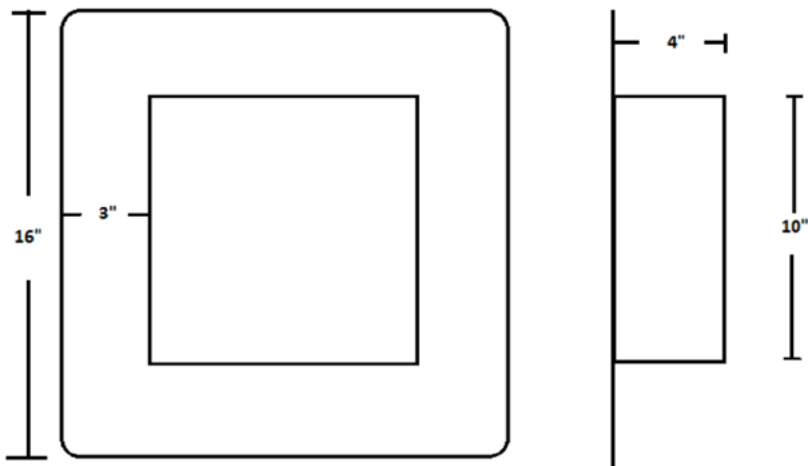

Nominal thickness 0.09" 2.3 mm

Total size 16"x16" 406mm x 406mm

Recessed size 10"x10" 254mm x 254mm

Weight 2lbs 0.9kg

Depth 4" 102mm

The Altro Whiterock recessed shelf meets multiple requirements associated with bathroom fixtures specified for BMH facilities. Unlike traditional recessed units which are metal and fixed with screws, this product is installed flush to pvc wall panels via a hygienic heat weld.

This secures the panel directly into the Altro Whiterock PVC wall panel creating an impervious seal that prevents moisture and bacteria from accumulating beneath the surface.

The welded seal makes it tamper-resistant and incapable of being weaponized for aggressive behavior. The tamper-resistant seal also prevents the creation of potential ligature points that patients can utilize for self-harm. This fixture also possesses durability similar to that of Altro Whiterock, allowing it to endure heavy impact without cracking or splintering.

Benefits:

- Ligature-resistant
- Tamper-resistant
- Heat welded seams
- Impact-resistant
- Durable

Ligature-resistant vinyl floor drains

Tamper-proof fixture



Whitehall Manufacturing
Model#: WHFDV-6RD-2NH

Tamper-proof, ligature-resistant clamping drains are an essential fixture in BMH bathrooms and shower areas. Secured with tamper-proof screws that can only be loosened via the corresponding specialty tool or removing the screw heads completely, these drains prevent misuse in low-supervision environments. The drain cover is designed with an internal gusset system to prevent ligature points.

Whitehall Manufacturing's WHFDV-6RD-2NH drain is provided with a ligature and vandal-resistant grate. It is also provided with a strainer head assembly designed for clamping vinyl flooring. It is a compatible option with Altro vinyl flooring.

Features:

- Ligature-resistant floor drain is designed with an internal gusset system in the grate assembly that helps prevent ligature points.
- The round top grate head is designed for clamping vinyl flooring or other waterproof material at the finish floor level.
- Reversible 4" flashing collar permits adjustment of grate to meet finished floor level.

Note: This product is designed to decrease the probability that it may be utilized as an apparatus for ligature. It is not a replacement for professionals who are trained in the proper evaluation, management and supervision of persons at risk of suicide.

Floor drain with surface membrane clamp

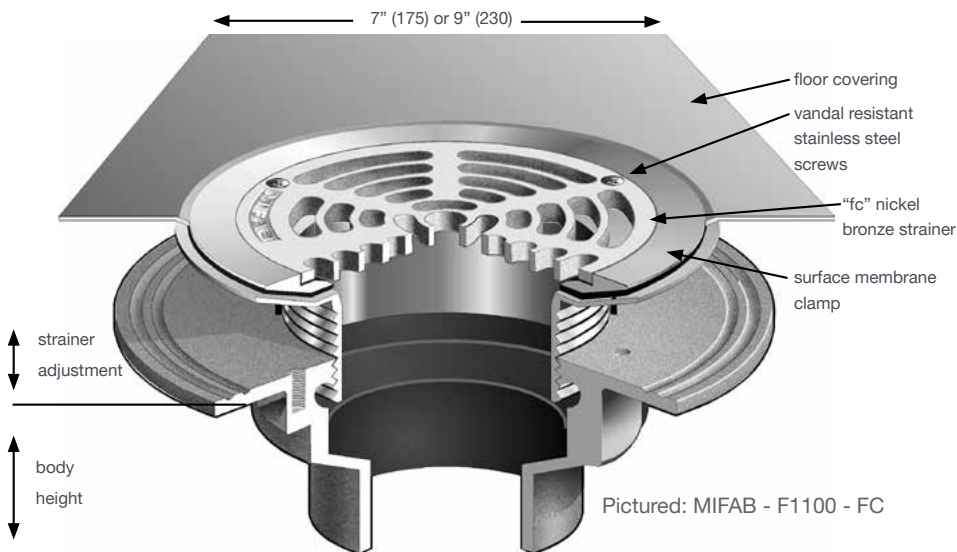

For Altro flooring to be successfully installed in wet areas (i.e. kitchens, showers, bathrooms, etc) all penetrations must be finished properly to prevent moisture from leaking under the floor. This is done by mechanically fastening the flooring in place with surface membrane clamping plumbing fixtures. These fixtures clamp and seal the flooring edge to prevent moisture from penetrating underneath the flooring.

Cutting the flooring material up to, or around, a drain, cleanout, trench drain, and other plumbing fixtures, is not a recommended installation method and will void the Altro Warranty. Please refer to our installation guide for the correct detailing or contact Altro technical services.

Note: Image on the left depicts a standard clamping drain, for mental health applications a ligature-resistant grate must be used.